



MedLED Chrome

Truly Cordless™ Headlight Technology



Denken, fühlen, modulare Beleuchtung...
unermüdliches Licht für das Leben!

Think, feel, modular illumination...
relentless light for life!

MedLED Chrome Stirnleuchten Headlights

Freiheit ohne Kompromisse

Die MedLED-Chrome-Stirnleuchte verfügt über die modernste Lichttechnologie, und erreicht so, was früher unmöglich war: eine Stirnleuchte, die jedes beliebige OP-Feld ausleuchten kann, sowohl in Bezug auf Lichtintensität als auch Spotgröße, und dabei lautlos, komfortabel und kabellos ist.

Merkmale

- Lichtintensität:
MC3 – 100.000 lux
MC6 – 200.000 lux
MC7 – 250.000 lux
- Akkulaufzeit:
MC3 – 7,75 Std.
MC6 – 6,75 Std.
MC7 – 3,50 Std.
- Akkulaufzeit: siehe oben, abhängig vom Modell; praktisch unbeschränkt dank Ladegerät mit 4 Ladeschächten
- USB-Ladedauer: 6,5 Stunden
- Ladedauer im 4-Schacht-Ladegerät: 10 Stunden; gleichzeitiges Aufladen von bis zu zwei Sets
- Justierung: volle Einstellbarkeit des Strahlwinkels, Links-Rechts-schwenkbar, größerer Spotgrößenbereich
- Spot-Qualität: scharf abgegrenzter, kreisförmiger Strahl mit homogenem Licht

Freedom without sacrifice

The MedLED Chrome headlight has incorporated the best that technology offers to accomplish the once impossible; a headlight that can light up any field in the O.R. in terms of both intensity and spot size and is silent, comfortable, and cordless.

Features

- Luminous intensity:
MC3 – 100,000 lux
MC6 – 200,000 lux
MC7 – 250,000 lux
- Battery service life:
MC3 – 7.75 hr
MC6 – 6.75 hr
MC7 – 3.50 hr
- Battery service life: see above, depends on model; infinite with 4-bay charger
- USB charging time: 6.5 hours
- 4-Bay charging time: 10 hours; charge up to two sets at a time
- Adjustability: full beam angle adjustability, left-to-right swivel, increased spot size range
- Spot quality: crisp, circular beam of homogenous light

MedLED Chrome

Freiheit ohne Kompromisse

Wenn Sie eine leistungsfähige, langlebige, komfortable Stirnleuchte ohne Kabel suchen, kann Ihnen KLS Martin ein vollständiges Sortiment an Stirnleuchten mit passendem Zubehör anbieten.

Freedom without sacrifice

If you have a need for a powerful, long lasting, comfortable headlight with no cord, KLS Martin is able to offer you a full range of headlights and accessories.



Intensität und Helligkeit Power and Brightness

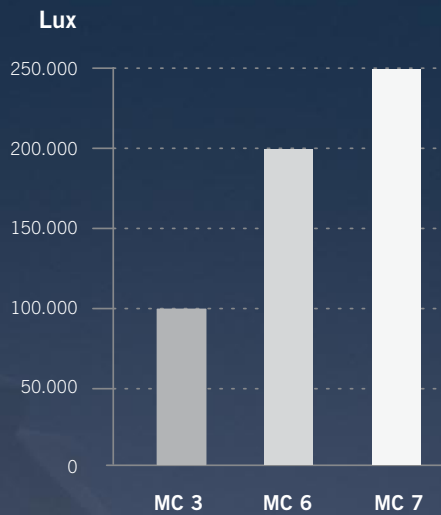

200 mm
MC 7

maximum spot diameter range
Maßstab/scale 1:1

100 mm
MC 3

90 mm
MC 6

MedLED Chrome

Integrierte Schaltkreise

Dies ist unsere Leitlinie.
Keine Gürteltasche, keine Kabel, keine Probleme,
sondern wirklich kabelloser Betrieb.
Licht ohne Kompromisse!

Keine Beeinträchtigung der Sterilität.
Ohne Kabel oder Akkupack am Gürtel.

Head-mounted circuit technology

That's our mission statement.
No cables, no hassles. Lose the optical cables
and belt pack cords and go cordless without
sacrificing basic operating light needs.

Does not interfere with sterility.
Without cables or battery belt packs,
it's kept safely above the neck.

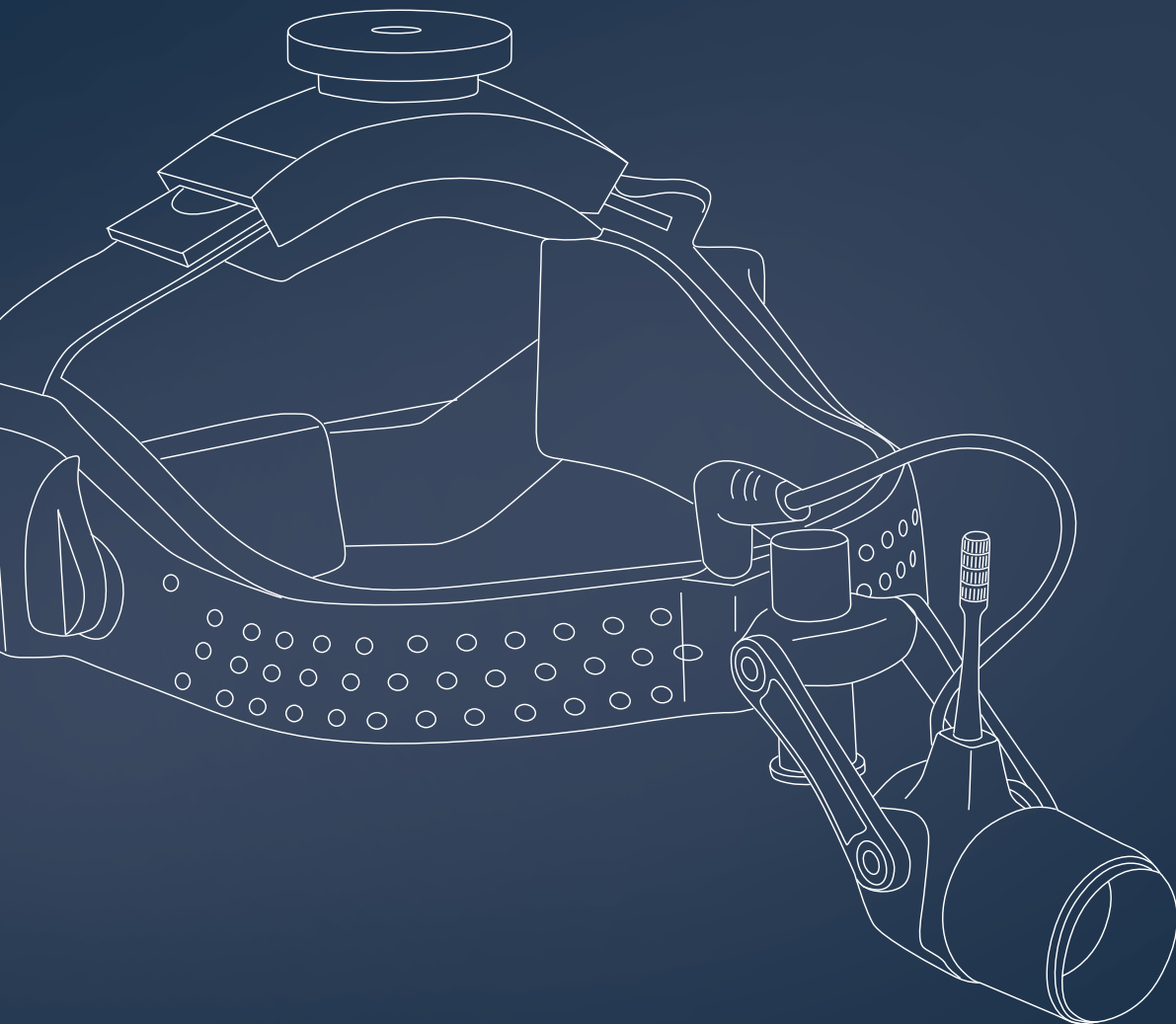

**Quiet-Cool™
Kühlkörper-Technologie**

Kühl und leise
Um unnötiges Erwärmen zu vermeiden, wird die LED mithilfe einer firmeneigenen Technologie sofort gekühlt. Wir haben außerdem das Gehäuse so gestaltet, dass es mögliche Restwärme selbst ableitet.

Lüfter brauchen mehr Strom und dadurch große Akkus, die an der Taille des Benutzers befestigt werden müssen. Hiermit gehören die Lüfter der Vergangenheit an.

**Quiet-Cool™
Heatsink technology**

Cool and quiet
Proprietary technology is used to cool the LED instantly, avoiding the potential for unnecessary heat buildup. We also designed the housing itself to manage any remaining thermal dissipation.

Fans also demand more power, requiring large batteries attached to the waist of the user.

**Einstellbarkeit und Steuerung des Spots
Spot Adjustability and Control**

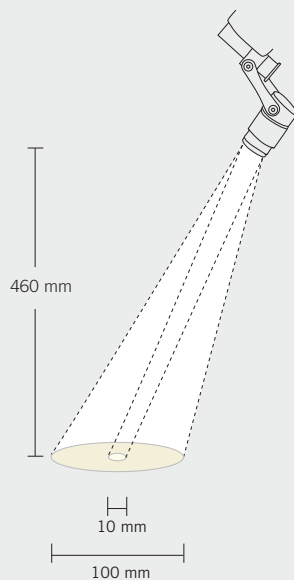

MC 3

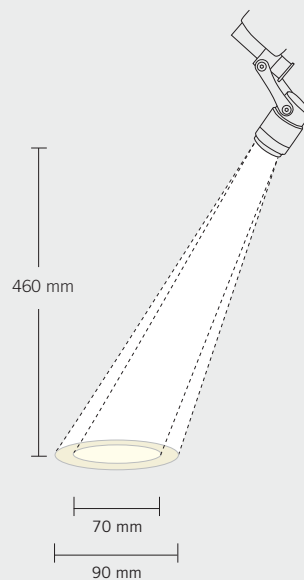

MC 6

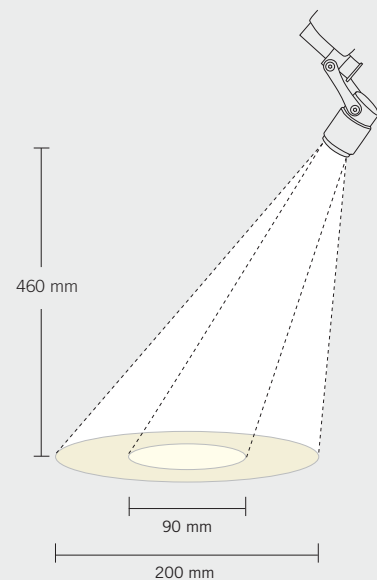

MC 7

MedLED Chrome

Stirnleuchten/Headlights

Ready to use!

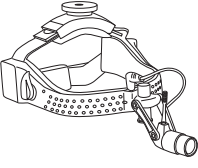
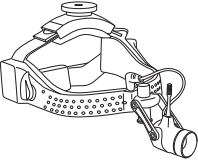
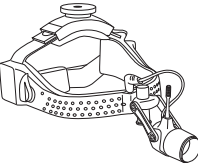
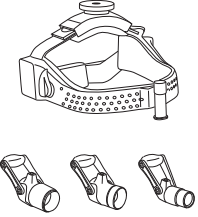
	<p>MedLED Chrome MC 3</p> <p>bestehend aus:</p> <p>Stirnleuchte MedLED Chrome MC 3, Transportkoffer, USB-Ladekabel, Netzteil inkl. Adapter EU, US, UK, AU und 2 Akkus (Lithium-Polymer)</p> <p>consisting of:</p> <p>headlight MedLED Chrome MC 3, carrying case, USB charging cable, PSU incl. adapter for EU, US, UK, AU and 2 rechargeable lithium-polymer batteries</p>	<p>Item No.</p> <p>17-500-40-04</p>
	<p>MedLED Chrome MC 6</p> <p>bestehend aus:</p> <p>Stirnleuchte MedLED Chrome MC 6, Transportkoffer, USB-Ladekabel, Netzteil inkl. Adapter EU, US, UK, AU und 2 Akkus (Lithium-Polymer)</p> <p>consisting of:</p> <p>headlight MedLED Chrome MC 6, carrying case, USB charging cable, PSU incl. adapter for EU, US, UK, AU and 2 rechargeable lithium-polymer batteries</p>	<p>Item No.</p> <p>17-500-50-04</p>
	<p>MedLED Chrome MC 7</p> <p>bestehend aus:</p> <p>Stirnleuchte MedLED Chrome MC 7, Transportkoffer, USB-Ladekabel, Netzteil inkl. Adapter EU, US, UK, AU und 2 Akkus (Lithium-Polymer)</p> <p>consisting of:</p> <p>headlight MedLED Chrome MC 7, carrying case, USB charging cable, PSU incl. adapter for EU, US, UK, AU and 2 rechargeable lithium-polymer batteries</p>	<p>Item No.</p> <p>17-500-60-04</p>
	<p>MedLED Chrome MC 3/6/7</p> <p>bestehend aus:</p> <p>Stirnleuchte MedLED Chrome MC 3, MC 6, MC 7, Transportkoffer, USB-Ladekabel, Netzteil inkl. Adapter EU, US, UK, AU und 2 Akkus (Lithium-Polymer)</p> <p>consisting of:</p> <p>headlight MedLED Chrome MC 3, MC 6, MC 7, carrying case, USB charging cable, PSU incl. adapter for EU, US, UK, AU and 2 rechargeable lithium-polymer batteries</p>	<p>Item No.</p> <p>17-500-70-04</p>

MedLED Chrome

Zubehör/Accessories

Vergößerungslinsen MC 3 Magnifier lenses MC 3

Vergößerung Magnification	Dioptren	Vergößerung	Erhöhung der Sehstärke	Optische Leistung	Empfohlener Arbeits- abstand (Brennweite)	Art.-Nr.
	Diopter	Magnification	Increase in eyesight	Optical power	Recommended working distance (focal length)	Item No.
	+ 2	+ 0.40	40 %	1.4 x	250 mm	17-500-12-04
	+ 3	+ 0.60	60 %	1.6 x	220 mm	17-500-13-04
	+ 4	+ 0.80	80 %	1.8 x	200 mm	17-500-14-04

Vergößerungslinsen MC 6 / MC 7 Magnifier lenses MC 6 / MC 7

Vergößerung Magnification	Dioptren	Vergößerung	Erhöhung der Sehstärke	Optische Leistung	Empfohlener Arbeits- abstand (Brennweite)	Art.-Nr.
	Diopter	Magnification	Increase in eyesight	Optical power	Recommended working distance (focal length)	Item No.
	+ 2	+ 0.40	40 %	1.4 x	250 mm	17-500-22-04
	+ 3	+ 0.60	60 %	1.6 x	220 mm	17-500-23-04
	+ 4	+ 0.80	80 %	1.8 x	200 mm	17-500-24-04

Ladegerät Desktop charger

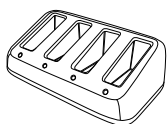

17-500-17-04

Ersatzakkus (2 St.) Spare batteries, rechargeable (2 pcs.)

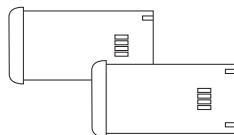

17-500-21-04

Koffer Carrying case

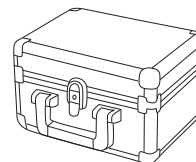

17-500-29-04

MedLED Chrome Zubehör/Accessories

Ersatzstirnbänder Spare head bands

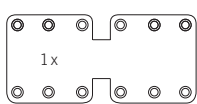

17-500-25-04
Hardtop

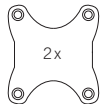

2x

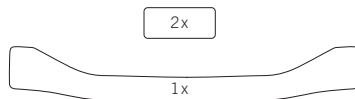

2x

1x

17-500-26-04
17-500-27-04
Hardtop

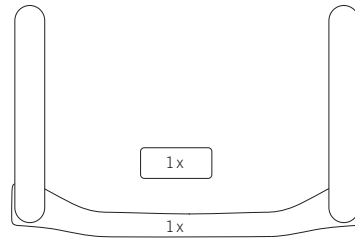

1x

1x

17-500-28-04
Softtop

GoPro Adapter

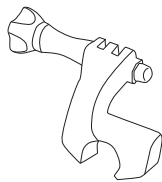

17-500-31-04

Ersatzkopfband Spare headstrap

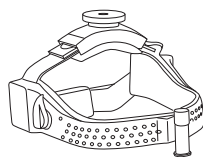

17-500-32-04
Hardtop

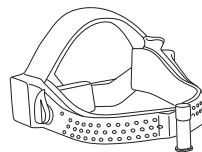

17-500-33-04
Softtop

Gelbfilter Amber filter



17-500-34-04
MC 3



17-500-35-04
MC 6

Leuchtkörper Bezel

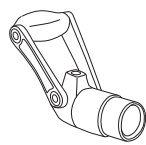

17-500-41-04
MC 3





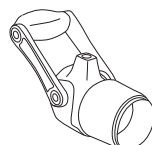

17-500-51-04
MC 6

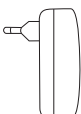

17-500-61-04
MC 7

Ladegerät/Netzstecker Desktop charger/Mains plug

		Art.-Nr. / Item No.	
		EU	17-500-01-04
		US	17-500-02-04
		UK	17-500-03-04
		AU	17-500-04-04

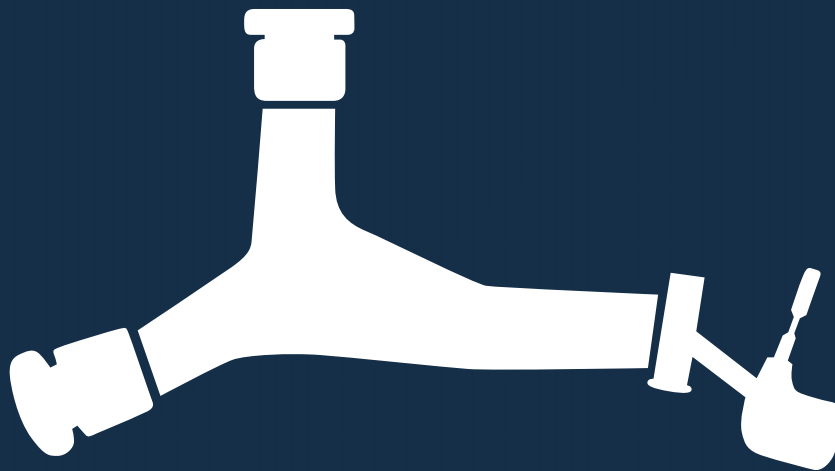

truly cordless™